

KoolBase

MOBILE SPOT COOLER

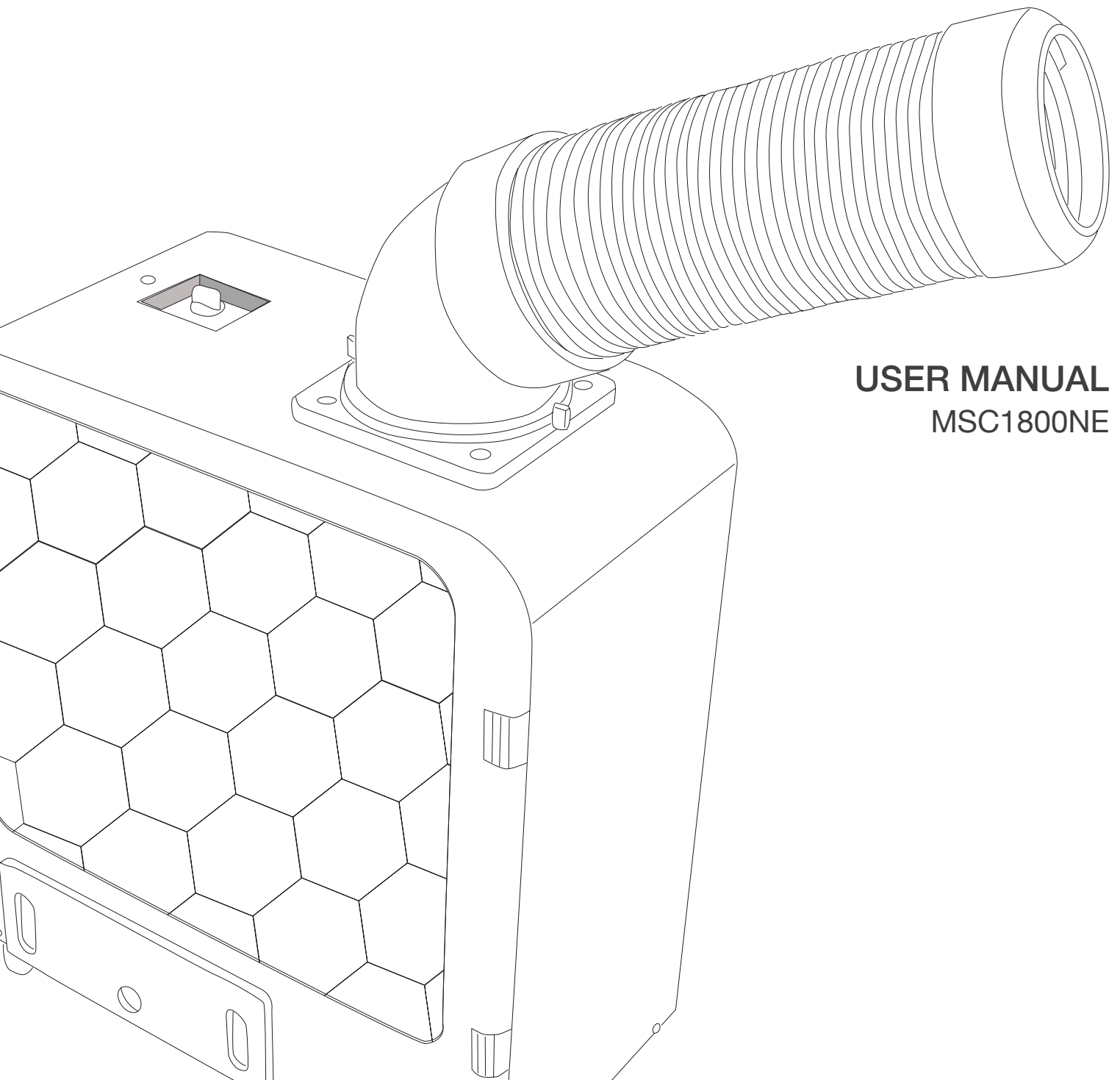

USER MANUAL
MSC1800NE





THANK YOU FOR PURCHASING THE KOOLBASE MOBILE SPOT COOLER.
PLEASE READ THE INSTRUCTIONS BEFORE USING.
KEEP THESE INSTRUCTIONS FOR REFERENCE.

TABLE OF CONTENTS

1. SAFETY PRECAUTIONS	PAGE 4,5
2. SPECIFICATIONS	PAGE 6
3. ACCESSORIES	PAGE 6
4. PARTS OF THE MACHINE	PAGE 7
5. INSTALLATION	PAGE 7
6. OPERATING INSTRUCTION	PAGE 8
7. MAINTENANCE AND INSPECTION	PAGE 11
8. TROUBLESHOOTING	PAGE 12





1. SAFETY PRECAUTIONS













Please read “Safety Precautions” carefully before operating the unit to reduce the risk of injury or damage.

 STOP	It may cause personal injury, fire, or other property damage if you neglect this mark and operate in the wrong way.
 FORBIDDEN	This mark stands for under any circumstances this unit should not be used.
 AS DIRECTED	This mark stands for only use as directed.
 NOTIFICATIONS / CAUTION	This mark stands for notification of use or to be aware of possible hazardous or unsafe situations.

FOR YOUR SAFETY, PLEASE FOLLOW THESE INSTRUCTIONS.

Please read carefully. The following should be read and understood.

	Please do not use the unit where flammable materials are used or stored (such as thinner, gasoline, kerosene, LPG, aluminum, magnesium, and plumbum). They could cause possible fire or explosion.
	Only a professional repair service should disassemble the unit in order to avoid warranty voidance or safety issues such as fire, electric shock, and injury. If you need repairs, please contact the manufacture or qualified repair service.
	Please do not operate the unit in the rain or wet areas.
	The power supply use only 115V single phase, otherwise it will cause the unit not to function properly.

	<p>Do not change or modify the unit. It could cause damage to the unit or property and will void warranty.</p>
	<p>Keep unit away from excessive heat or fire. It may cause damage to the unit.</p>
	<p>Use only grounded outlet.</p>
	<p>The unit operates in the temperature range from 64°F to 104°F, otherwise it may cause the unit to slow the air flow or shutdown.</p>
	<p>Turn off the unit to move location or lock casters.</p>
	<p>If the unit is stopping, has excessive noise, or abnormal odor, please stop use immediately.</p>
	<p>To prevent an accident or damage, the unit can not be used in the following locations:</p> <ul style="list-style-type: none"> • Not grounded. • Unlevel ground. • Stairs, emergency exit or entrance. • Area of strong wind, heavy dust or metal powder.
	<p>Hold plug when pulling out of outlet. Otherwise, the plug may be damaged or sparking could occur.</p>
	<p>Unplug unit if storing or non-use for a period time.</p>
	<p>Unplug unit for repair or installation.</p>
	<p>Do not bend, pull, bind, clip, or change the power cord. It may cause accidents such as fire or electrical shock.</p>
	<p>Do not use unit on a boat.</p>

2. SPECIFICATIONS

POWER / FREQUENCY	Single Phase 115 V / 60 Hz
LOAD CURRENT	5.6 A
CONSUMPTION POWER	675 W
COOLING CAPACITY	6,100 BTU
COMPRESSOR	Fully Closed Type Rotary
REFRIGERANT	R410 A
REFRIGERANT (RATED CHARGE)	340 g
WATER STORAGE CAPACITY	3 L
CONDENSATE WATER HANDLING METHOD	Condensation Tank / Drain Pipe
SIZE	18" x 10" x 23"
WEIGHT	50 LB
OPERATING TEMPERATURE LIMIT	(77°F - 113°F)

3. ACCESSORIES

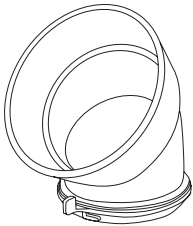

Curved Duct

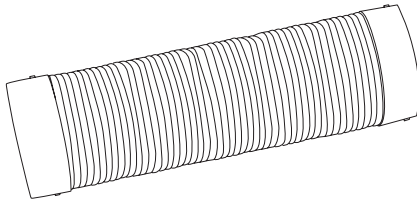

Cooling Duct

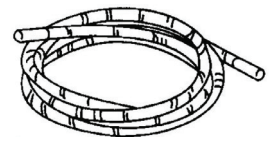

Drain Hose

4. PARTS OF THE MACHINE

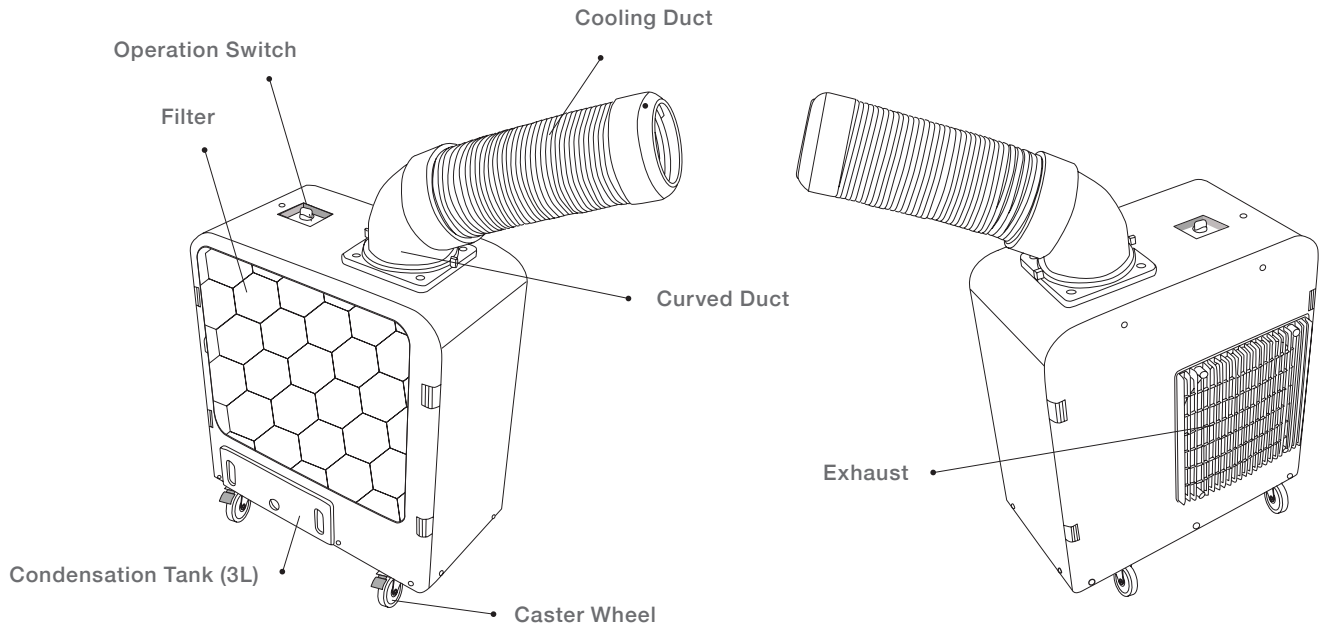

5. INSTALLATION

• INSTALLING THE CURVED DUCT

Line up the nubs on the curved duct with slot on the cold air exit. Turn locking ring until it is locked position.

• INSTALLING THE COOLING DUCT

Slide the cooling duct raised nub in to the slot of the curved duct. Then turn clockwise to lock. Make sure the duct is connected properly before using. When adjusting the direction, turn the curved duct instead of the cooling duct.

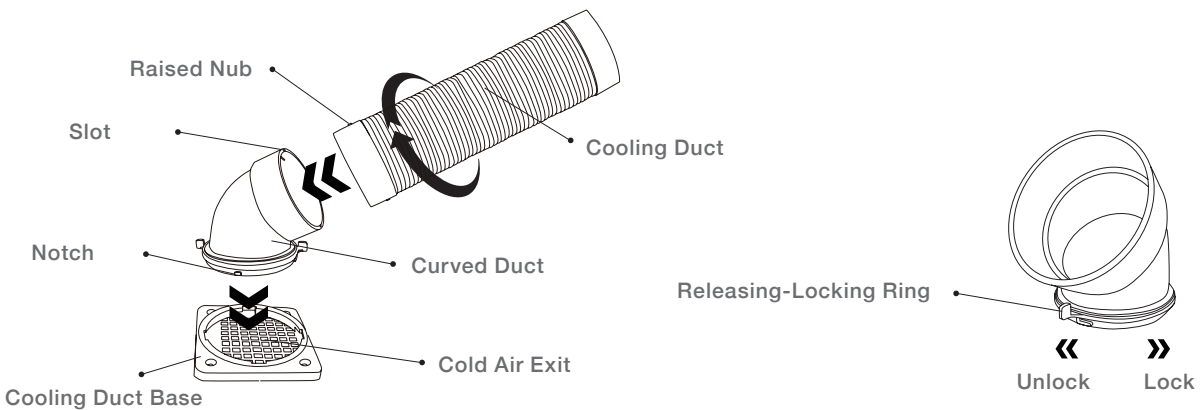

Cooling Duct Installation

Curved Duct Installation

• POWER SUPPLY CONNECTION

Please use a dedicated power outlet.

Please use a grounded circuit breaker with a 15A capacity.

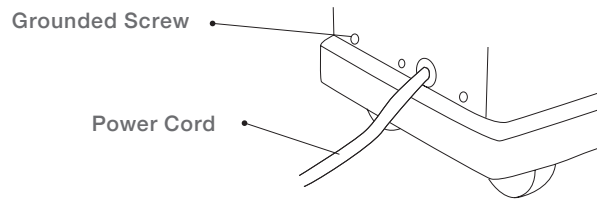

6. OPERATING INSTRUCTION

OPERATION SWITCH INFORMATION

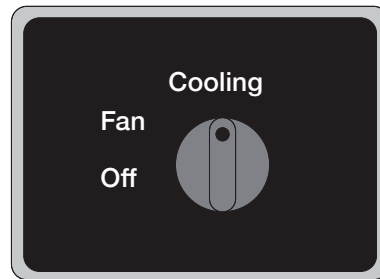

- To power on, turn on the switch at the top of the unit to fan or cooling for operation.

There are 2 options:

1. Fan - Air flow at ambient temperature.
2. Cooling - Sends a flow of cold air at fan speed.

NOTIFICATION

- Operating temperature is between 64°F to 104°F.
- If you use the unit out of the temperature range, it may not work properly.
- Do not overload the electrical system by using too many devices off one outlet.

- **COMPRESSOR OVERLOAD / OVERHEAT PROTECTION**

If the compressor overheats or overloads due to high or low voltage or high ambient temperature, the built in safety protection for the compressor will start working and turn off the unit.

⚠ NOTIFICATION

When the overload protection is working, the air flow from the unit will be at the ambient temperature of the room, but will not cool the air.

If overload protection works frequently, find out, and fix the problem before using the unit.

- **ADJUSTING THE AIR FLOW DIRECTION.**

Please adjust the duct to get the desired cooling direction. The cooling duct adjustment range is 360° horizontal and 50° vertical.

⚠ NOTIFICATION

Please adjust the angle of the cooling duct before using the unit. Hold the curved duct and bend the cooling duct for angle adjustment.

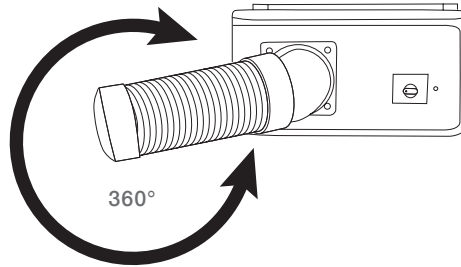

- **KEEP DISTANCE**

Make sure the unit has minimum distance from any wall, ceiling, or object as illustrated below. In order to prevent accidents, the unit should be placed on level ground. Unlevel ground, stairs, emergency exits should not be used.

Minimum distance needed is 12" from any wall. While the unit operates, please do not place obstructions in front of the filter, cooling, or heating exhaust duct.

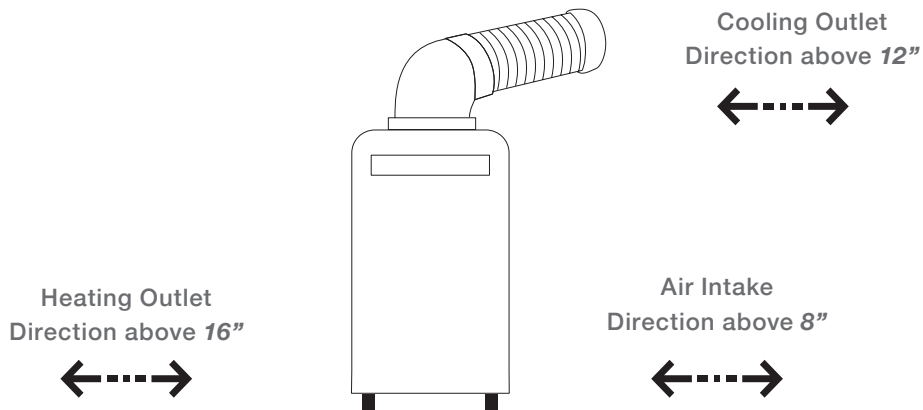

KoolBase

- **CONDENSATION TANK.**

The dehumidified water will flow into condensation tank. The capacity of the tank is 3L.
The condensation tank can be taken out manually from the unit.

⚠ NOTIFICATION

Please check the amount of the water periodically. Drain the water before moving the unit.
Empty the water immediately when the water gets to the red line. The unit does not have a warning device.

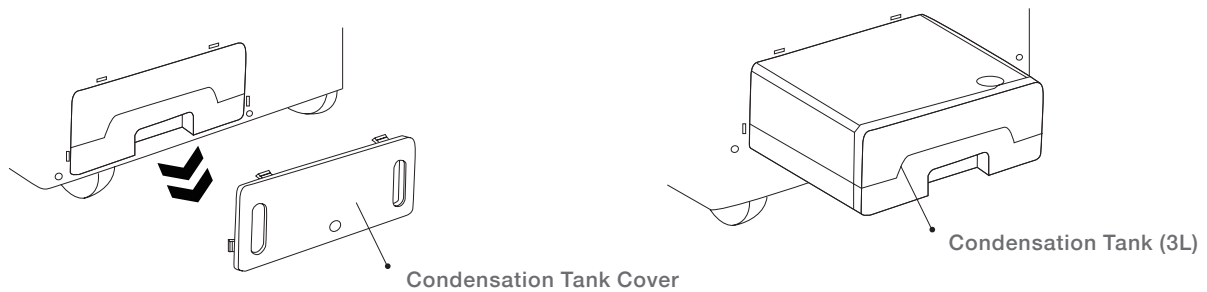

- **CASTER WHEEL LOCK / UNLOCK**

The front wheels come with locks. For safety, lock the casters and check the unit for movement.

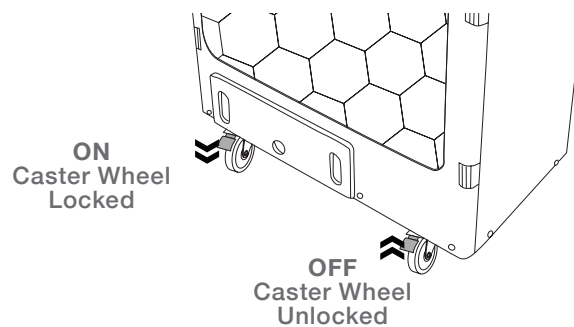

7. MAINTENANCE AND INSPECTION

NOTIFICATION

Please clean the filter regularly.

- When cleaning filter with heavy use, consider vacuuming filter before rinsing. Rinse with water and dry thoroughly before reuse.
- When cleaning the surface of the unit, do not use abrasive materials or chemicals which could damage the unit surface.

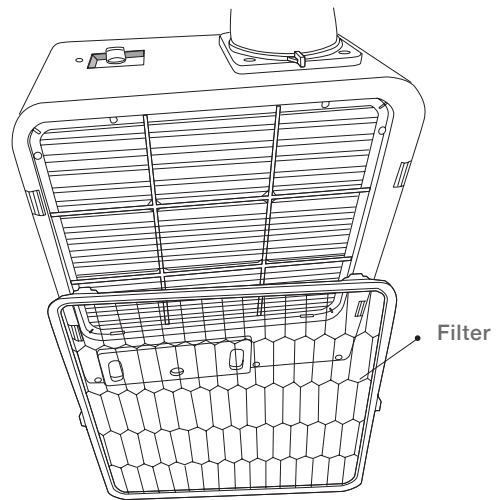

8. TROUBLESHOOTING

PROBLEM	CAUSE	SOLUTION
NOT RUNNING	<ul style="list-style-type: none"> • The power plug is loose or disconnected. • The breaker switch has turned off. 	<ul style="list-style-type: none"> • Insert the plug into the wall outlet. • Check breaker on main panel and reset. • Ask the technical service department for assistance.
NO REFRIGERATION	<ul style="list-style-type: none"> • The condenser surface is dirty and blocked. • The heat exhaust fan not working. • The external environment temperature is too high. • The compressor is not working. • The refrigeration system pipeline is blocked. • Possible power overload. 	<ul style="list-style-type: none"> • Clean the condenser surface and vents. • Check fan. • Move to more a suitable place to use. • Check the capacitor to the compressor. • Check pipeline system and clean. • Check for proper voltage.
WATER LEAKS OUT	<ul style="list-style-type: none"> • The drain pipe is blocked. • The filter is dirty. • The condensation tank is full of water. 	<ul style="list-style-type: none"> • Clean out the drain pipe. • Clean the filter. • Remove tank and empty the water.

- The warranty period of this machine is one year. Our company has a technical department to provide service to our customers.
- If the customer disassembles or modifies the unit in any way, the unit is not covered by the warranty.
- If the unit is out of warranty, the customer is responsible for service and additional costs if needed.



KOOLBASE MANUFACTURER'S RECOMMENDATIONS

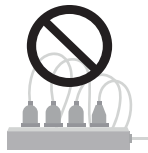

1. USE A DEDICATED OUTLET. DO NOT SHARE AN OUTLET WITH OTHER DEVICES.
SHARING AN OUTLET MAY CAUSE A POWER OUTAGE.



2. IF USING AN EXTENSION CORD, A 12 AWG IS RECOMMENDED.



3. DO NOT BLOCK THE HEAT EXHAUST DUCT.
BLOCKING THE HEAT EXHAUST COULD CAUSE THE UNIT
TO OVERHEAT AND STOP WORKING PROPERLY.



PLEASE NOTE

OPTIMUM OPERATING TEMPERATURE RANGE FOR
KOOLBASE MOBILE SPOT A/C COOLER
IS FROM **64 - 104°** FAHRENHEIT.

PROPER USAGE OF THIS UNIT, AT THE COOLING DUCT,
WILL REDUCE THE AMBIENT TEMPERATURE
BETWEEN **10 - 15°** FAHRENHEIT.

KoolBase