

KOOLZONE

MOBILE SPOT COOLER



FOR MORE INFO

USER MANUAL

SAC-3000AS

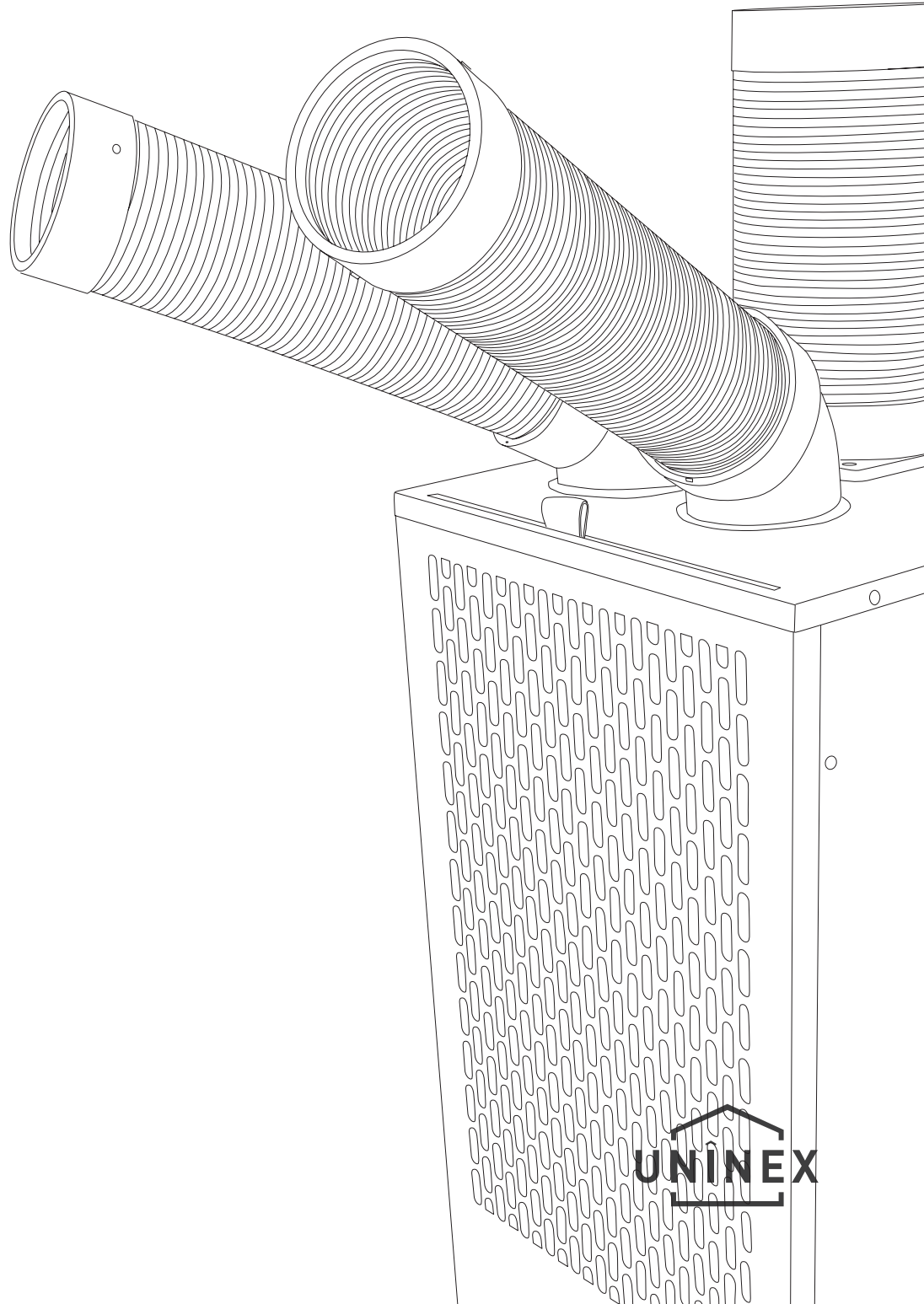



THANK YOU FOR PURCHASING THE KOOLZONE MOBILE SPOT COOLER.

PLEASE READ THE INSTRUCTIONS BEFORE USING.





KEEP THESE INSTRUCTIONS FOR REFERENCE.

TABLE OF CONTENTS

| | |
|-------------------------------------|----------|
| 1. SAFETY PRECAUTIONS | PAGE 4,5 |
| 2. SPECIFICATIONS | PAGE 6 |
| 3. ACCESSORIES | PAGE 6 |
| 4. PARTS OF THE MACHINE | PAGE 7 |
| 5. INSTALLATION | PAGE 7 |
| 6. OPERATING INSTRUCTION | PAGE 9 |
| 7. MAINTENANCE AND INSPECTION | PAGE 13 |
| 8. TROUBLESHOOTING | PAGE 14 |





1. SAFETY PRECAUTIONS













Please read "Safety Precautions" carefully before operating the unit to reduce the risk of injury or damage.

| | |
|--|---|
|  STOP | It may cause personal injury, fire, or other property damage if you neglect this mark and operate in the wrong way. |
|  FORBIDDEN | This mark stands for under any circumstances this unit should not be used. |
|  AS DIRECTED | This mark stands for only use as directed. |
|  NOTIFICATIONS / CAUTION | This mark stands for notification of use or to be aware of possible hazardous or unsafe situations. |

FOR YOUR SAFETY, PLEASE FOLLOW THESE INSTRUCTIONS.

Please read carefully. The following should be read and understood.

| | |
|---|--|
|  | Please do not use the unit where flammable materials are used or stored (such as thinner, gasoline, kerosene, LPG, aluminum, magnesium, and plumbum). They could cause possible fire or explosion. |
|  | Only a professional repair service should disassemble the unit in order to avoid warranty voidance or safety issues such as fire, electric shock, and injury. If you need repairs, please contact the manufacture or qualified repair service. |
|  | Please do not operate the unit in the rain or wet areas. |
|  | The power supply use only 115V single phase, otherwise it will cause the unit not to function properly. |

| | |
|---|---|
|  | <p>Do not change or modify the unit. It could cause damage to the unit or property and will void warranty.</p> |
|  | <p>Keep unit away from excessive heat or fire. It may cause damage to the unit.</p> |
|  | <p>Use only grounded outlet.</p> |
|  | <p>The unit operates in the temperature range from 64°F to 104°F, otherwise it may cause the unit to slow the air flow or shutdown.</p> |
|  | <p>Turn off the unit to move location or lock casters.</p> |
|  | <p>If the unit is stopping, has excessive noise, or abnormal odor, please stop use immediately.</p> |
|  | <p>To prevent an accident or damage, the unit can not be used in the following locations:</p> <ul style="list-style-type: none"> • Not grounded. • Unlevel ground. • Stairs, emergency exit or entrance. • Area of strong wind, heavy dust or metal powder. |
|  | <p>Hold plug when pulling out of outlet. Otherwise, the plug may be damaged or sparking could occur.</p> |
|  | <p>Unplug unit if storing or non-use for a period time.</p> |
|  | <p>Unplug unit for repair or installation.</p> |
|  | <p>Do not bend, pull, bind, clip, or change the power cord. It may cause accidents such as fire or electrical shock.</p> |
|  | <p>Do not use unit on a boat.</p> |

2. SPECIFICATIONS

| | | |
|------------------------------------|----------------------------|--------|
| POWER / FREQUENCY | Single phase 115 V / 60 Hz | |
| LOAD CURRENT | High | Low |
| | 10.8 A | 10.4 A |
| CONSUMPTION POWER | 1210 W | 1170 W |
| COOLING CAPACITY | 10,236 BTU | |
| COMPRESSOR | Fully Closed Type Rotary | |
| REFRIGERANT | R410 A | |
| REFRIGERANT (RATED CHARGE) | 800 g | |
| SIZE | 18.5" x 17.7" x 38.9" | |
| WEIGHT | 126 LB | |
| OPERATING TEMPERATURE LIMIT | (77°F - 113°F) | |

- Refrigeration capability and electric features are tested at 94°F room temperature and 60% humidity.

3. ACCESSORIES

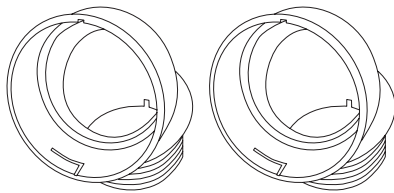

Curved Duct

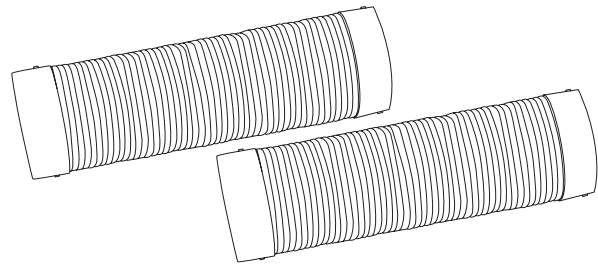

Cooling Duct

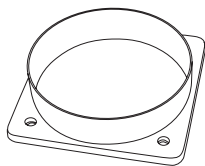

Heat Exhaust Duct Socket

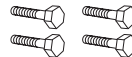

Screws

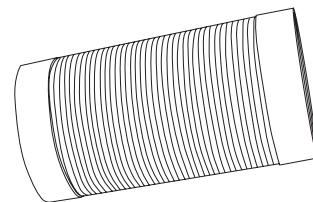

Heat Exhaust Duct

4. PARTS OF THE MACHINE

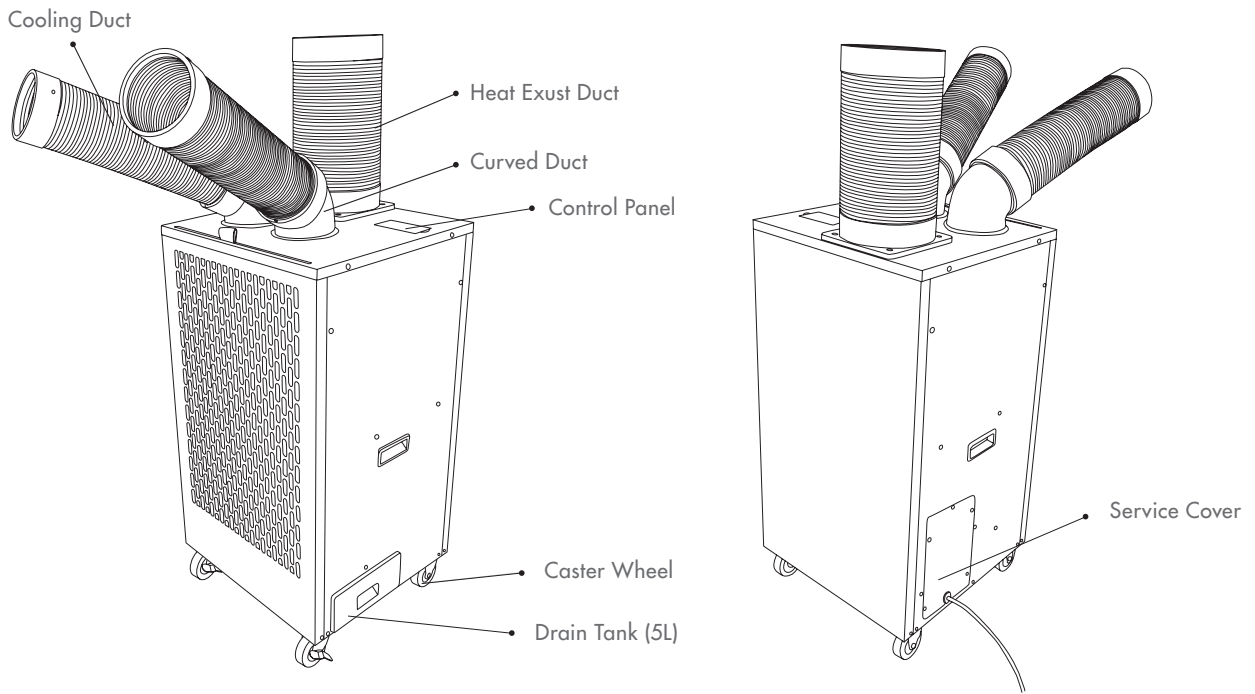

5. INSTALLATION

• INSTALLING THE CURVED DUCT

Make sure the notch part (molded arrow on duct) lines up with the slotted black line in the cold air exit. Install and turn to center the curved duct with the front of the unit.

• INSTALLING THE COOLING DUCT

Slide the cooling duct raised nub into the slot of the curved duct. Then turn clockwise to lock. Make sure the duct is connected properly before using. When adjusting the direction, turn the curved duct instead of the cooling duct.

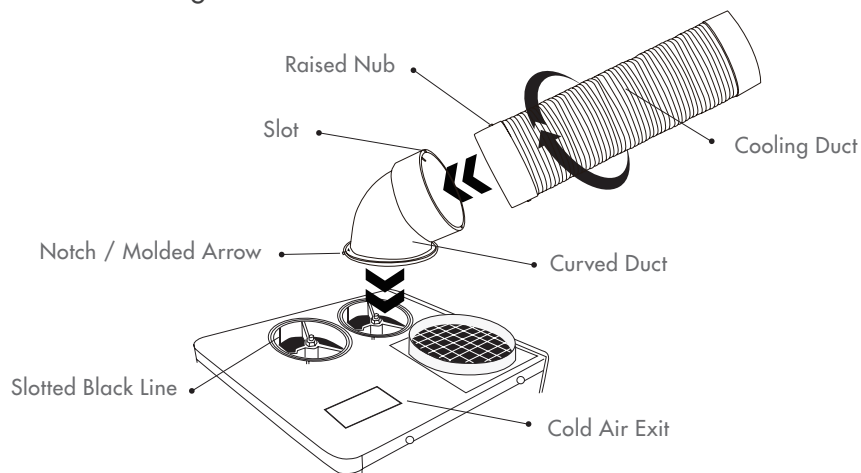

Cooling Duct Installation

- **INSTALLING THE HEAT EXHAUST DUCT AND SOCKET**

The heat exhaust duct socket uses 4 ST4×12 bolts to fix the heat vent.

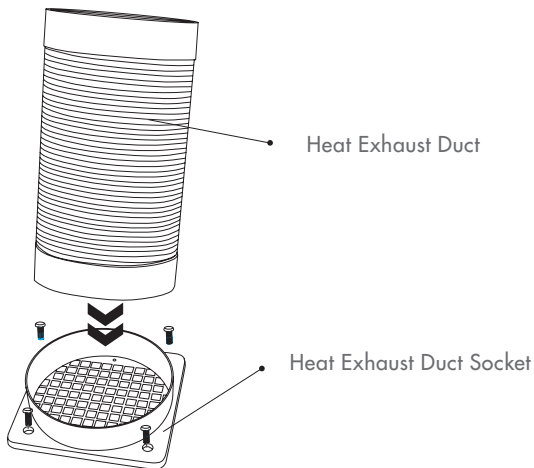

- **POWER SUPPLY CONNECTION**

Please use a dedicated power outlet.

Please use a grounded circuit breaker with a 15A capacity.

⚠ NOTIFICATION

- Operating temperature is between 77°F to 113°F.
- If you use the unit out of the temperature range, it may not work properly.
- If the unit is moved and/or tilted, please wait at least 3 hours for the refrigerant to stabilize before turning on the unit.
- After pressing the power button to stop the unit, please wait at least 3 minutes before restarting. The unit may not work sooner due to a built in safety protection.
- Before using the auto-swing function, make sure there are no obstructions.
- Do not use the auto-swing feature if a cooling extension duct is installed.
- Do not overload the electrical system by using too many devices off one outlet.

6. OPERATING INSTRUCTION

OPERATION SWITCH INFORMATION

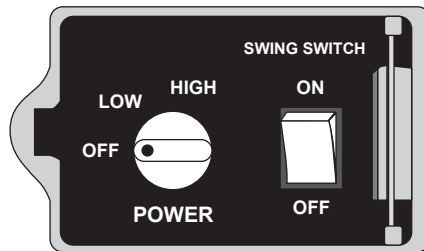

- To power on, turn on the switch at the top of the unit to low or high cooling for operation.

There are 2 options:

1. Low Cooling - Sends a flow of cold air at low fan speed.
 2. High Cooling - Sends a flow of cold air at high fan speed.
- Swing switch.
Press on and the two cold ducts will automatically oscillate.
Press off to stop.

NOTIFICATION

- If you use the unit out of the temperature range, it may not work properly.
- Do not overload the electrical system by using too many devices off one outlet.

• COMPRESSOR OVERLOAD / OVERHEAT PROTECTION

If the compressor overheats or overloads due to high or low voltage or high ambient temperature, the built in safety protection for the compressor will start working and turn off the unit.

NOTIFICATION

When the overload protection is working, the air flow from the unit will be at the ambient temperature of the room, but will not cool the air.

If overload protection works frequently, find out, and fix the problem before using the unit.

- **ADJUSTING THE AIR FLOW DIRECTION.**

Please adjust the duct to get the desired cooling and heating direction. The cooling duct adjustment range is 200° horizontal and 50° vertical. The heat exhaust duct adjustment range is 40°.

⚠ NOTIFICATION

Please adjust the angle of the cooling duct and heating exhaust duct before using the unit. Hold the curved duct and bend the cooling duct for angle adjustment.

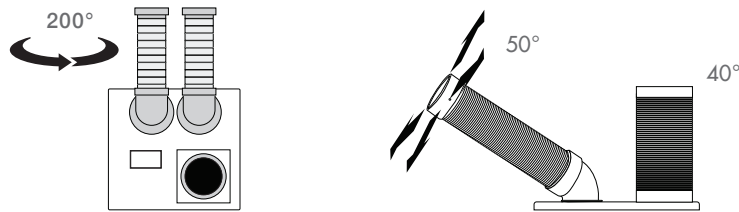

- **KEEP DISTANCE**

Make sure the unit has minimum distance from any wall, ceiling, or object as illustrated below. In order to prevent accidents, the unit should be placed on level ground. Unlevel ground, stairs, emergency exits should not be used.

Minimum distance needed is 12" from any wall. While the unit operates, please do not place obstructions in front of the filter, cooling, or heating exhaust duct.

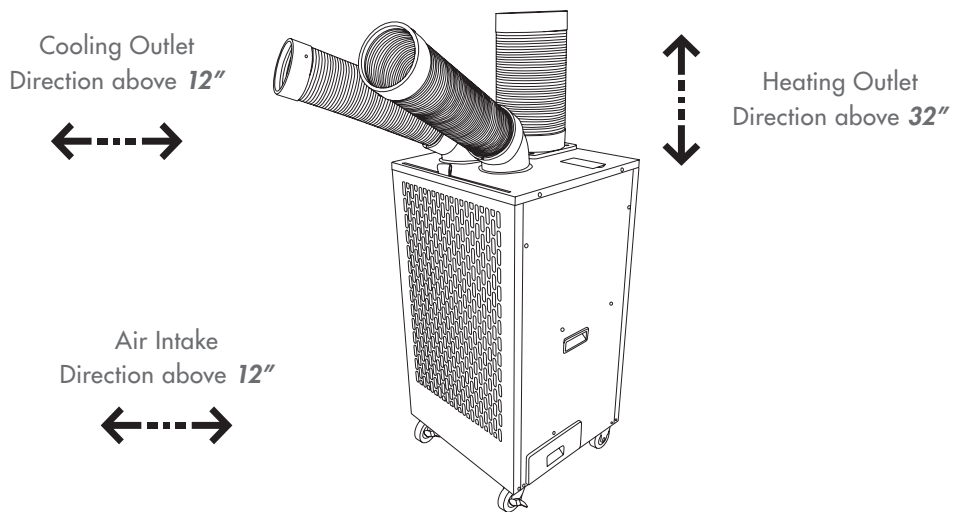

- **CONDENSATION TANK.**

The dehumidified water will flow into condensation tank. The capacity of the tank is 5L.

The condensation tank can be taken out manually from the unit.

! NOTIFICATION

Please check the amount of the water periodically. Drain the water before moving the unit.

Empty the water immediately when the water gets to the red line. The unit does not have a warning device.

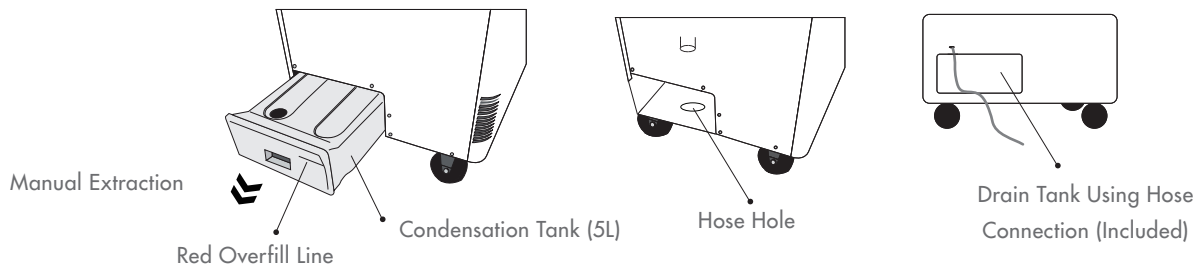

- **CASTER WHEEL LOCK / UNLOCK**

The front wheels come with locks. For safety, lock the casters and check the unit for movement.



7. MAINTENANCE AND INSPECTION

NOTIFICATION

Please clean the filter regularly.

- When cleaning filter with heavy use, consider vacuuming filter before rinsing. Rinse with water and dry thoroughly before reuse.
- When cleaning the surface of the unit, do not use abrasive materials or chemicals which could damage the unit surface.

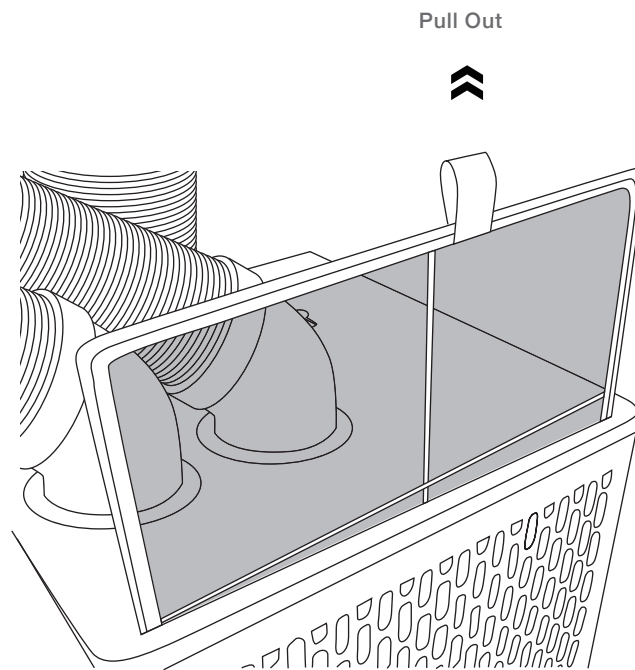

8. TROUBLESHOOTING

| PROBLEM | CAUSE | SOLUTION |
|-------------------------|--|--|
| NOT RUNNING | <ul style="list-style-type: none"> • The power plug is loose or disconnected. • The breaker switch has turned off. | <ul style="list-style-type: none"> • Insert the plug into the wall outlet. • Check breaker on main panel and reset. • Ask the technical service department for assistance. |
| NO REFRIGERATION | <ul style="list-style-type: none"> • The condenser surface is dirty and blocked. • The heat exhaust fan not working. • The external environment temperature is too high. • The compressor is not working. • The refrigeration system pipeline is blocked. • Possible power overload. | <ul style="list-style-type: none"> • Clean the condenser surface and vents. • Check fan. • Move to more a suitable place to use. • Check the capacitor to the compressor. • Check pipeline system and clean. • Check for proper voltage. |
| WATER LEAKS OUT | <ul style="list-style-type: none"> • The drain pipe is blocked. • The filter is dirty. • The water tank is full of water. | <ul style="list-style-type: none"> • Clean out the drain pipe. • Clean the filter. • Remove drain cap and empty the water. |

- The warranty period of this machine is one year. Our company has a technical department to provide service to our customers.
- If the customer disassembles or modifies the unit in any way, the unit is not covered by the warranty.
- If the unit is out of warranty, the customer is responsible for service and additional costs if needed.



KOOLZONE MANUFACTURER'S RECOMMENDATIONS

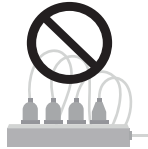

1. USE A DEDICATED OUTLET. DO NOT SHARE AN OUTLET WITH OTHER DEVICES.
SHARING AN OUTLET MAY CAUSE A POWER OUTAGE.



2. IF USING AN EXTENSION CORD, A 12 AWG IS RECOMMENDED.



3. DO NOT BLOCK THE HEAT EXHAUST DUCT.
BLOCKING THE HEAT EXHAUST COULD CAUSE THE UNIT
TO OVERHEAT AND STOP WORKING PROPERLY.



4. FOR OPTIMUM PERFORMANCE, USE ONLY UP TO A MAXIMUM OF
12 FT OF HEAT/COOL EXTENSION DUCT.

KOOLZONE



PLEASE NOTE

OPTIMUM OPERATING TEMPERATURE RANGE FOR
KOOLZONE MOBILE SPOT A/C COOLER
IS FROM **77° - 113°** FAHRENHEIT.

WHEN USING THIS UNIT ON COOLING MODE,
THE AMBIENT TEMPERATURE WILL BE REDUCED
BETWEEN **10° - 15°** FAHRENHEIT.

MAKE LIFE SIMPLE AND MORE CONVENIENT
WITH UNINEX



CONTACT US FOR PURCHASE OR RENTAL



EXCLUSIVELY DISTRIBUTED BY:
UNINEX INTERNATIONAL

5780 SMITHWAY STREET COMMERCE, CA 90040
T. 800-864-3288 / 323-890-9246 / F. 323-890-9249



MANUFACTURE:
NAKATOMI CO.,LTD.

6445-2, TAKAI, TAKAYAMA, KAMITAKAI, NAGANO, JAPAN